

A-A KESİTİ  
Ölçek: 1/100

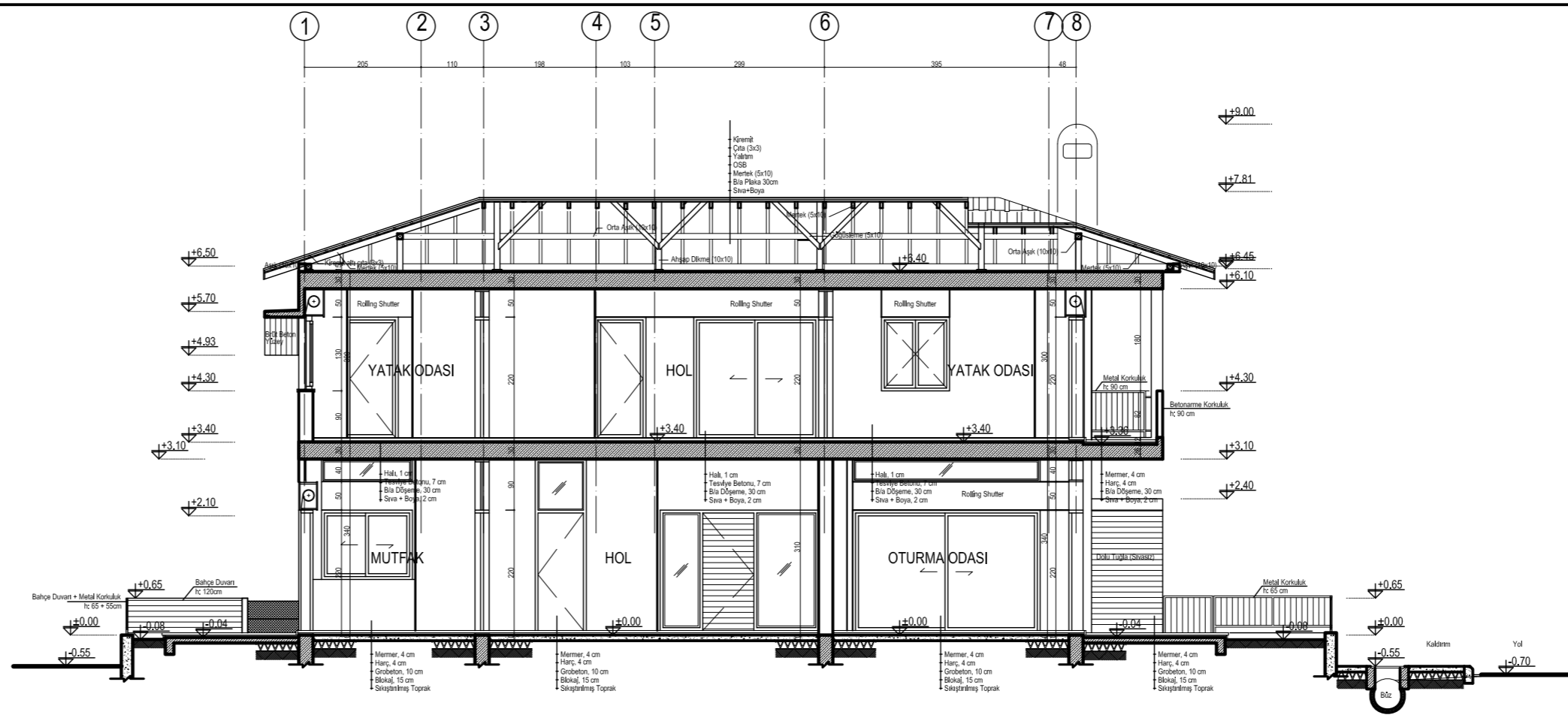

B-B KESİTİ  
Ölçek: 1/100

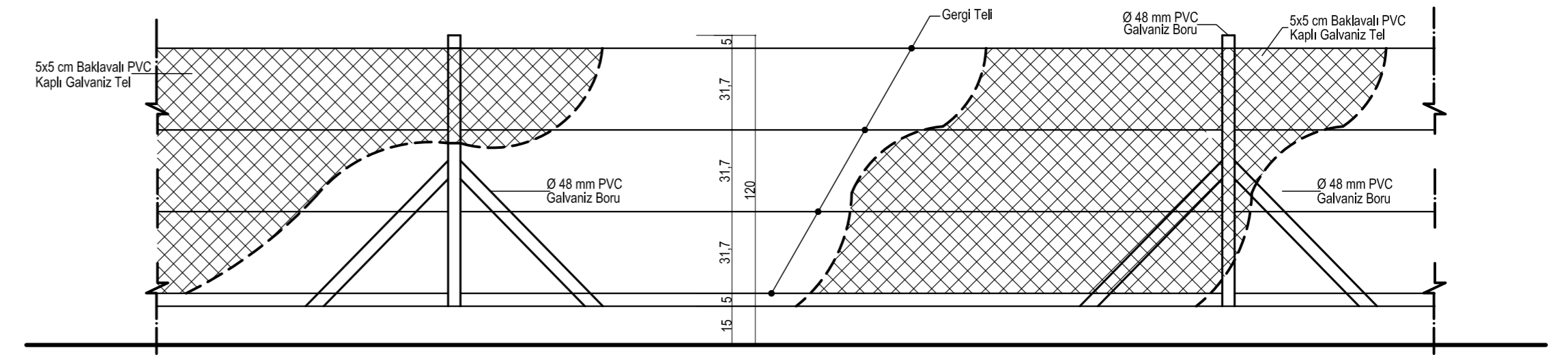

TELLEME ÖN GÖRÜNÜŞÜ Ölçek: 1/20

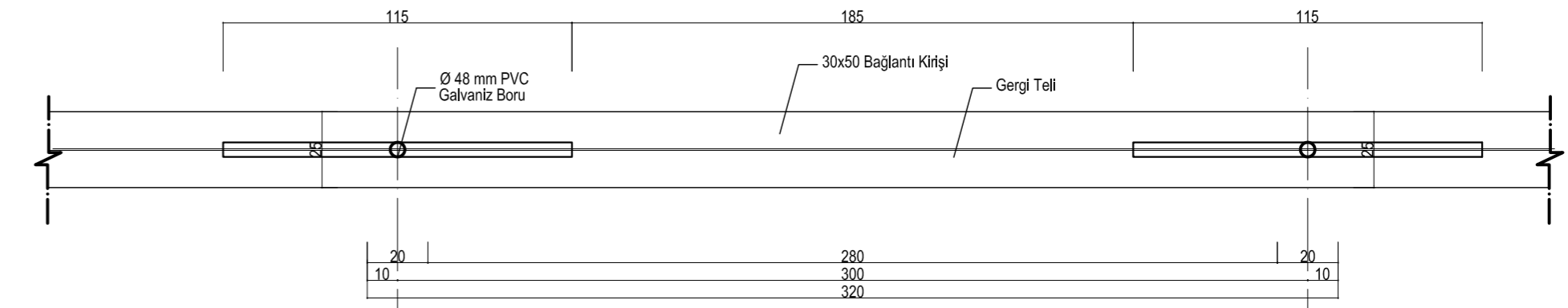

TELLEME PLAN Ölçek: 1/20

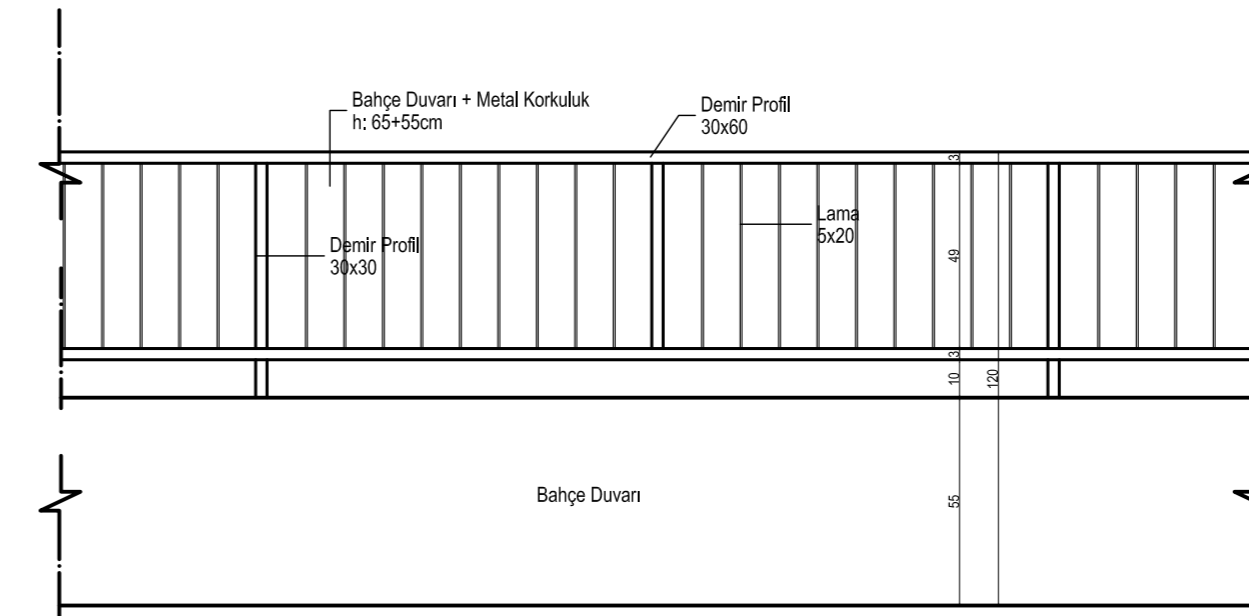

BAHÇE DUVARI ÖN GÖRÜNÜŞÜ Ölçek: 1/20

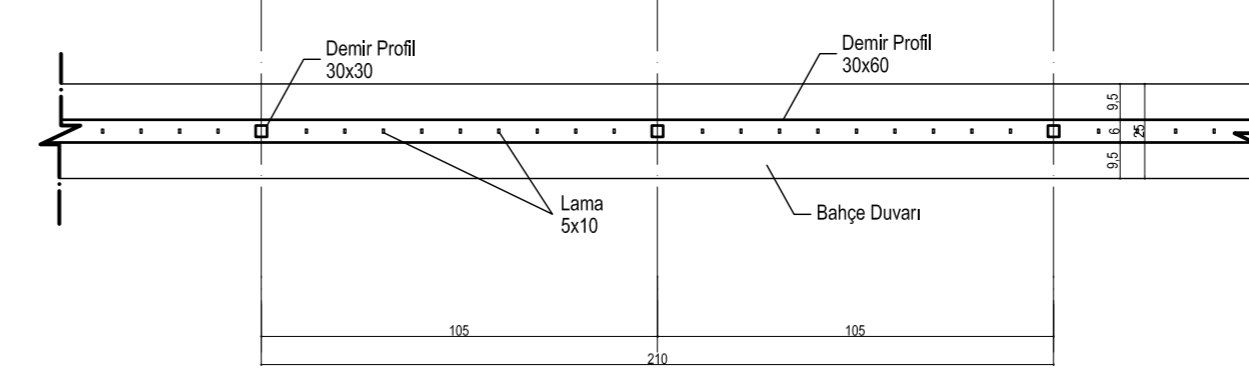

BAHÇE DUVARI PLAN Ölçek: 1/20

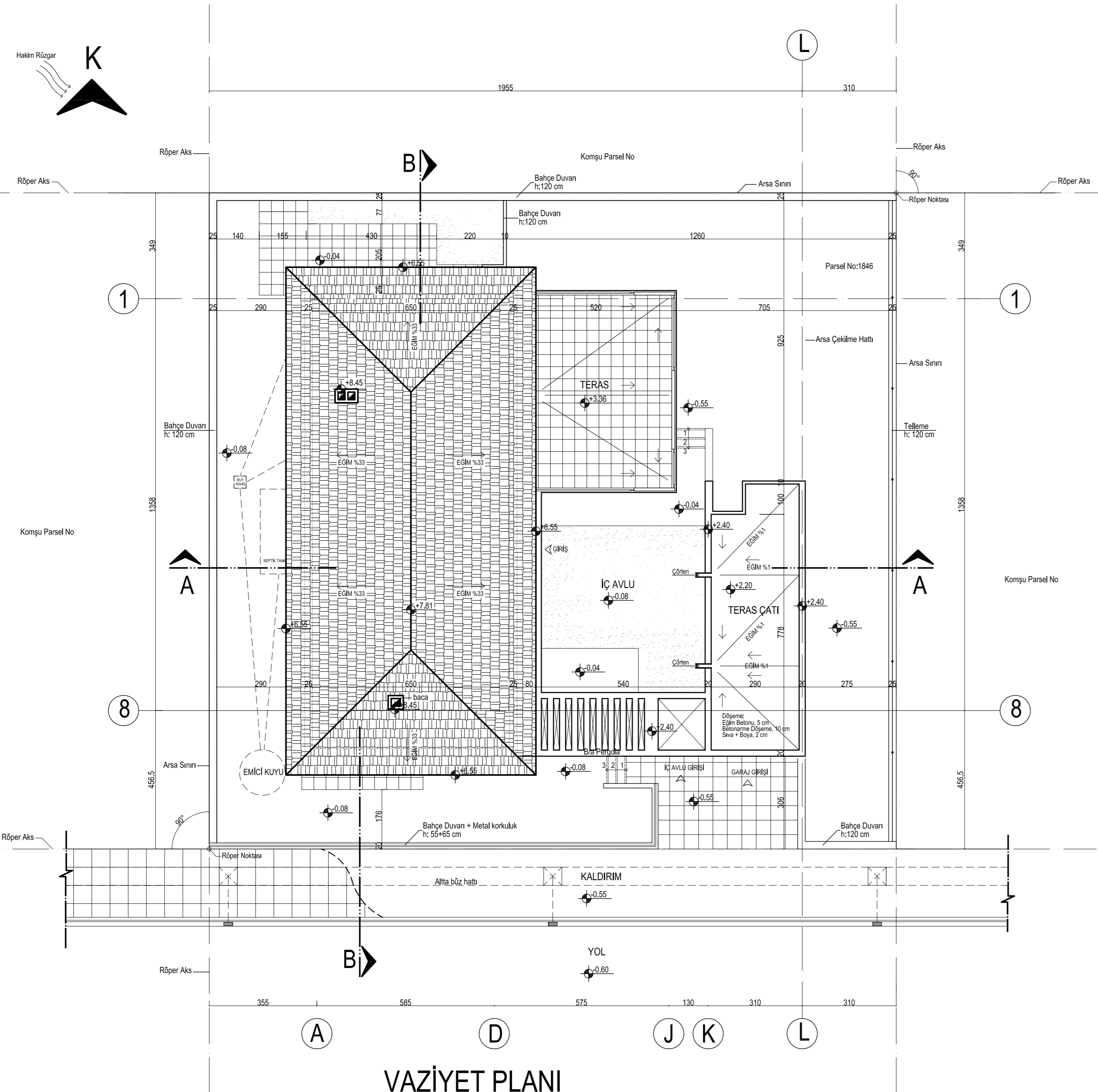

VAZİYET PLANI  
ÖLÇEK: 1/100

.....'ya  
AIT KONUT PROJESİ

ODA VİZESİ

MİMARİ:	Ahmed V. Beaheddin	1
STATİK:	.....	
MEKANİK:	.....	
ELEKTİRİK:	.....	

KAZASI	BELEDİYE	KÖYÜ	MAHALLESİ	SOKAK VEYA CADDESİ	ADA No BLOK	PAFTA No	PARSEL No KITA No
Lefkoşa	Lefkoşa	-	Köşkköy/Şifli	Mehmet Akif Cad.	A	XXI	392

İNSAAT YAPISI SINIFI	İNSAAT SİSTEMİ	BİRİM MALİYETİ TL/m <sup>2</sup>	ALAN m <sup>2</sup>	YAPIL YAKLAŞIK MALİYETİ	KAT ADEDİ BODRUM ÇATI DAHİL	KULLANIM AMACI	AZAMI İNŞAAT SÜRESİ

PAFTA	VAZİYET PLANI, TELLEME VE BAHÇE DUVARI DETAYI	
ÇİZEN	.....	
TARİH:	PAFTA No: M01	ÖLÇEK: 1/100, 1/20

ZEMİN KAT MAHAL TABLOSU

MAHAL	YER	DUVAR	TAVAN
Oturma Odası	Mermer	Siva + Boya	Siva + Boya
Yemek Odası	Mermer	Siva + Boya	Siva + Boya
Mutfak	Mermer	Fayans	Siva + Boya
Hol	Mermer	Siva + Boya	Siva + Boya
Wc	Mermer	Fayans	Siva + Boya
Balkon	Mermer	Siva + Boya	Siva + Boya
Kazan Odası	Mermer	Siva + Boya	Siva + Boya
Garaj	Şap	Siva + Boya	Siva + Boya
Ambar	Mermer	Siva + Boya	Siva + Boya
Odunluk	Şap	Siva + Boya	Siva + Boya

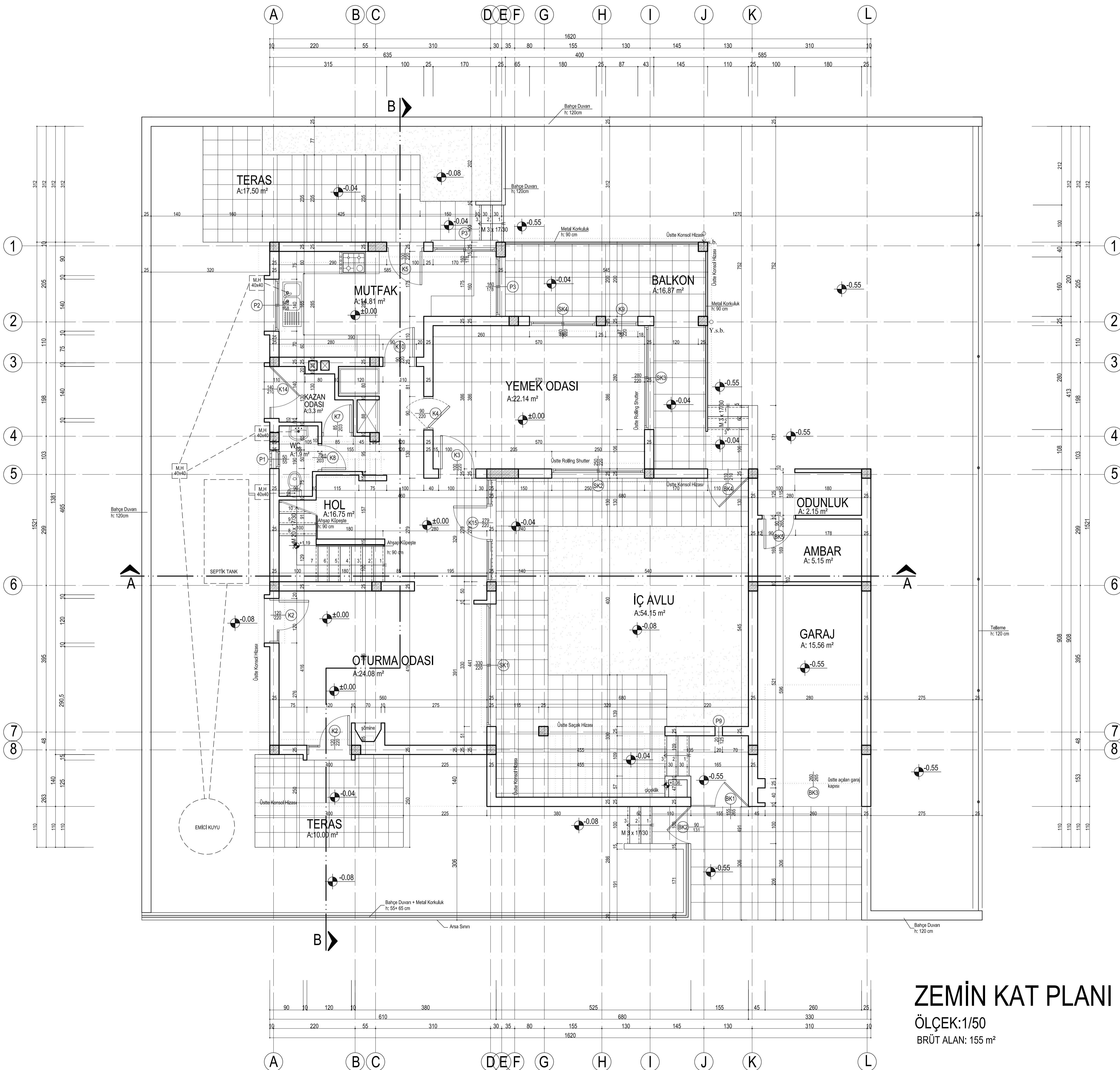

..... 'ya  
 AİT KONUT PROJESİ

MİMARİ: Ahmet V. Beaheddin

PAFTA ZEMİN KAT PLANI

ÇİZEN .....

TARİH .....

PAFTA No:  
M02

ÖLÇEK: 1/50

## I. KAT MAHAL TABLOSU

MAHAL	YER	DUVAR	TAVAN
Yatak Odası	Hali	Sıva + Boya	Sıva + Boya
Dikiş Odası	Hali	Sıva + Boya	Sıva + Boya
Banyo	Mermer	Fayans	Sıva + Boya
Hol	Hali	Sıva + Boya	Sıva + Boya
Teras	Mermer	Sıva + Boya	-

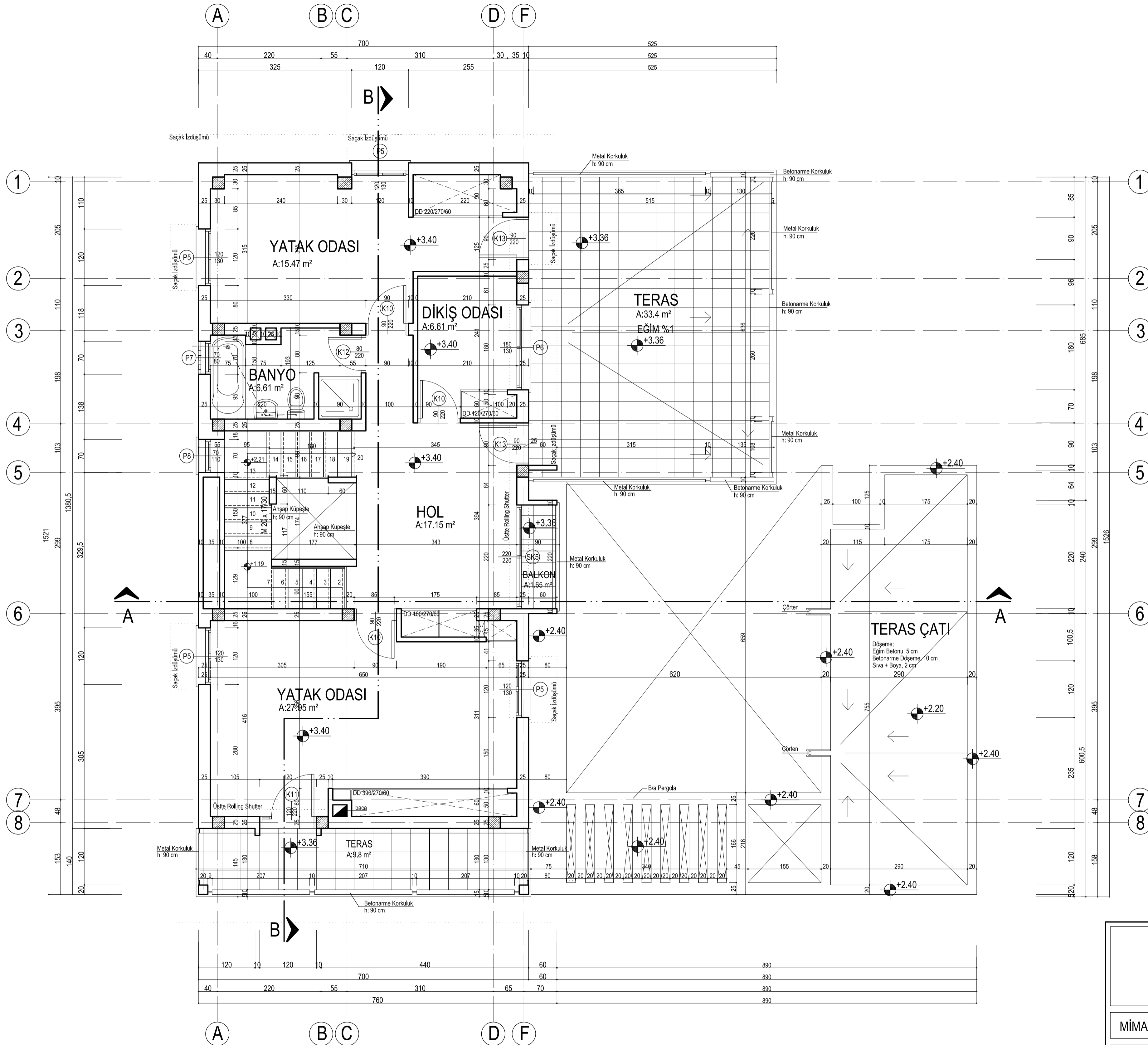

## 1. KAT PLANI

ÖLÇEK:1/50

BRÜT ALAN: 107.7 m²

..... 'ya  
AİT KONUT PROJESİ

MİMARİ: Ahmet V. Beaheddin

PAFTA I. KAT PLANI

ÇİZEN .....

TARİH .....

PAFTA No:  
M03

ÖLÇEK:1/50

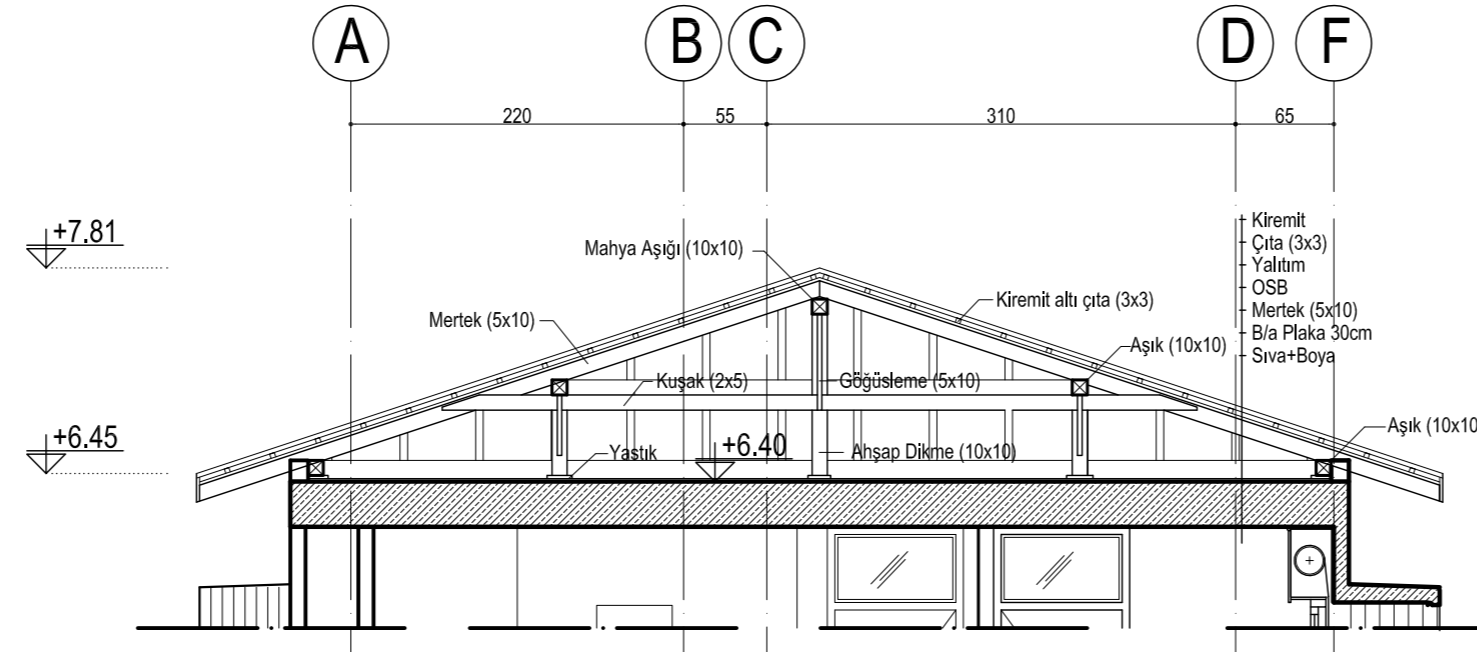

## A-A KESİTİ

Ölçek: 1/50

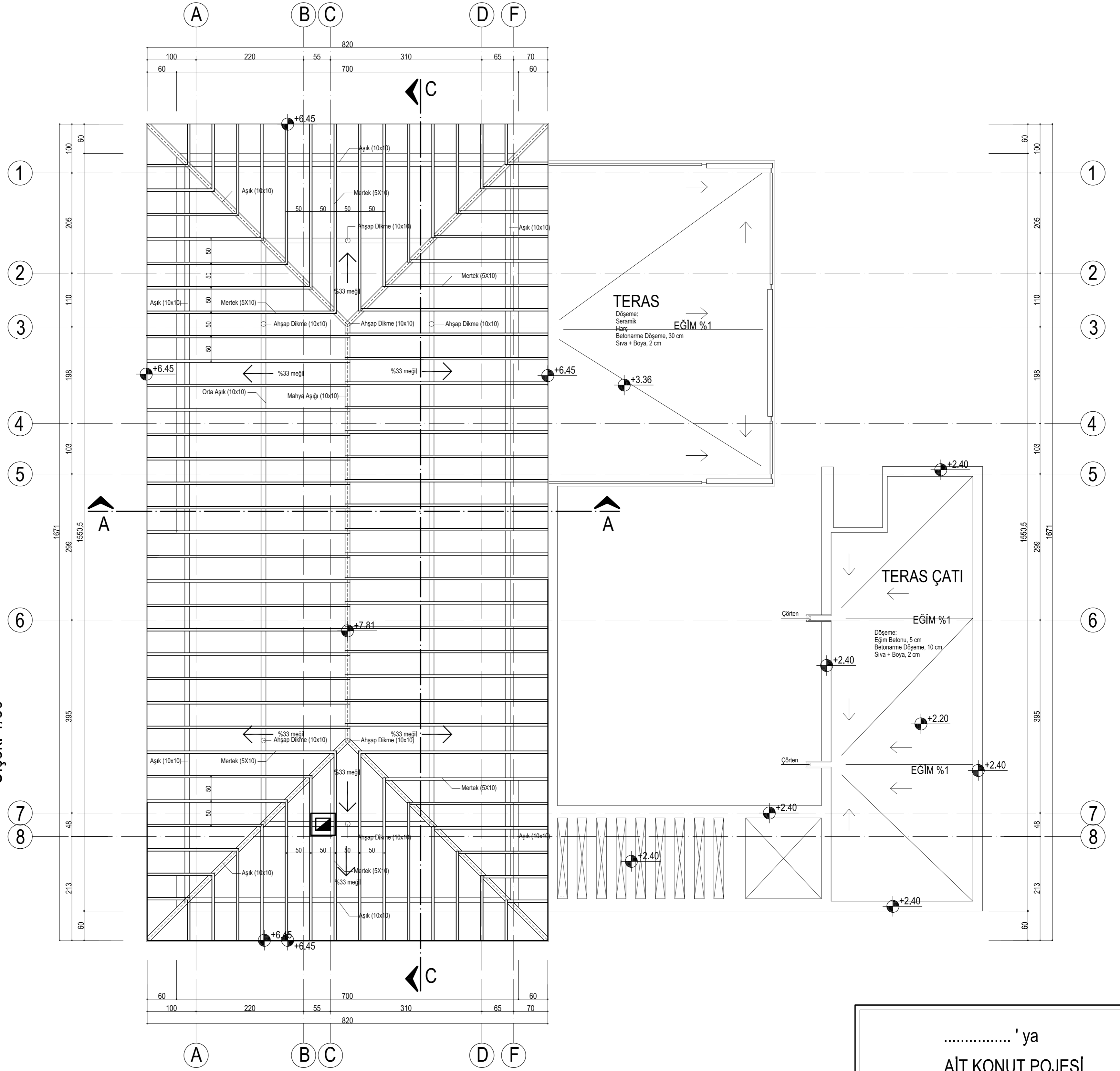

## ÇATI PLANI

Ölçek: 1/50

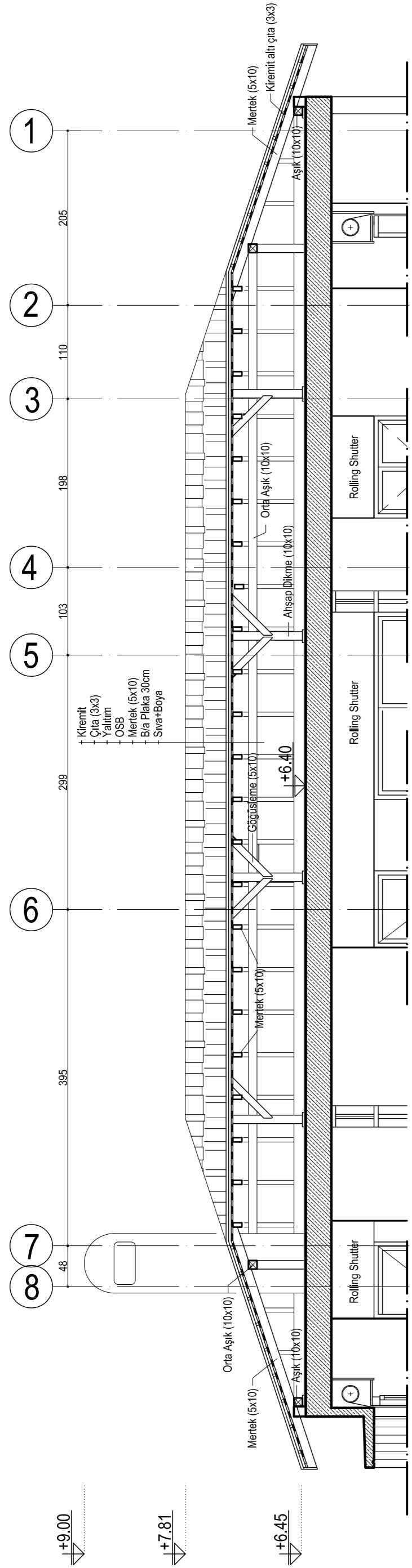

## C-C KESİTİ

Ölçek: 1/50

..... 'ya		
AİT KONUT PROJESİ		
MİMARİ: Ahmet V. Beaheddin		
PAFTA	ÇATI PLANI	
ÇİZEN	.....	
TARİH	PAFTA No: M04	ÖLÇEK:1/50

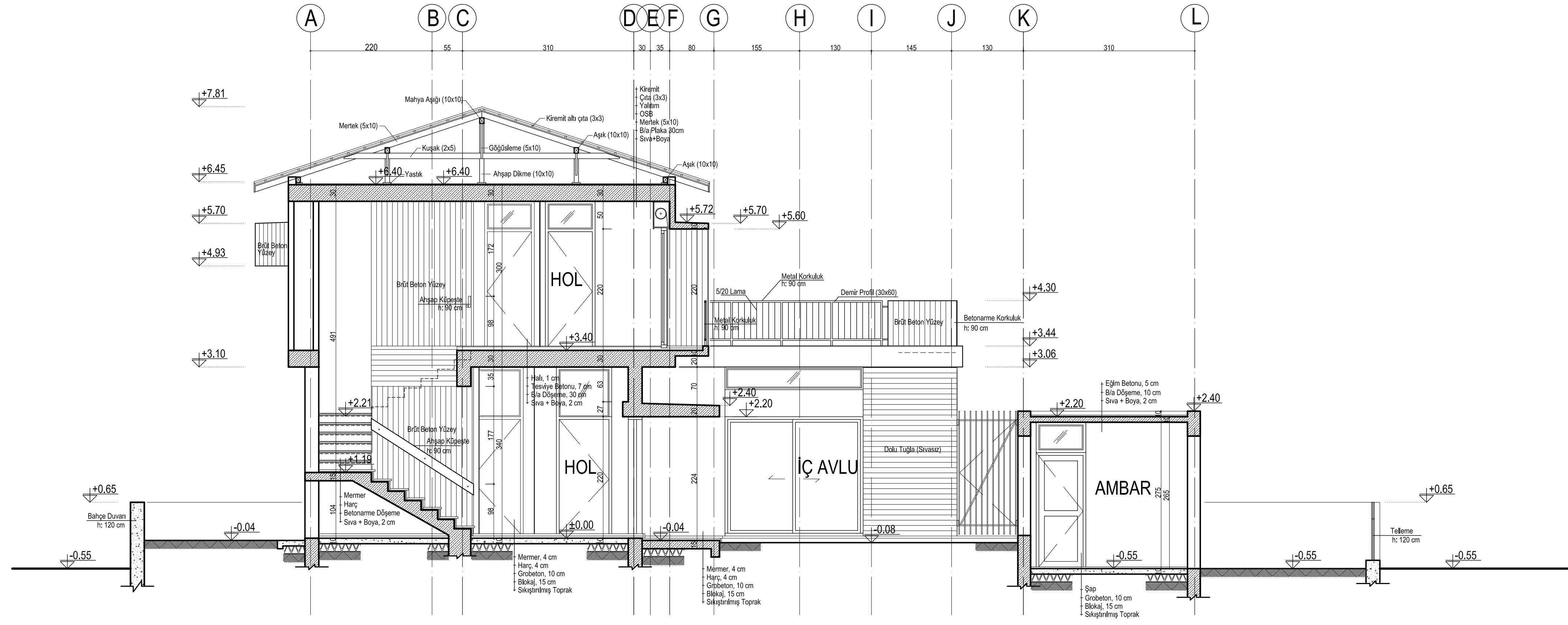

## A-A KESİTİ

Ölçek: 1/50

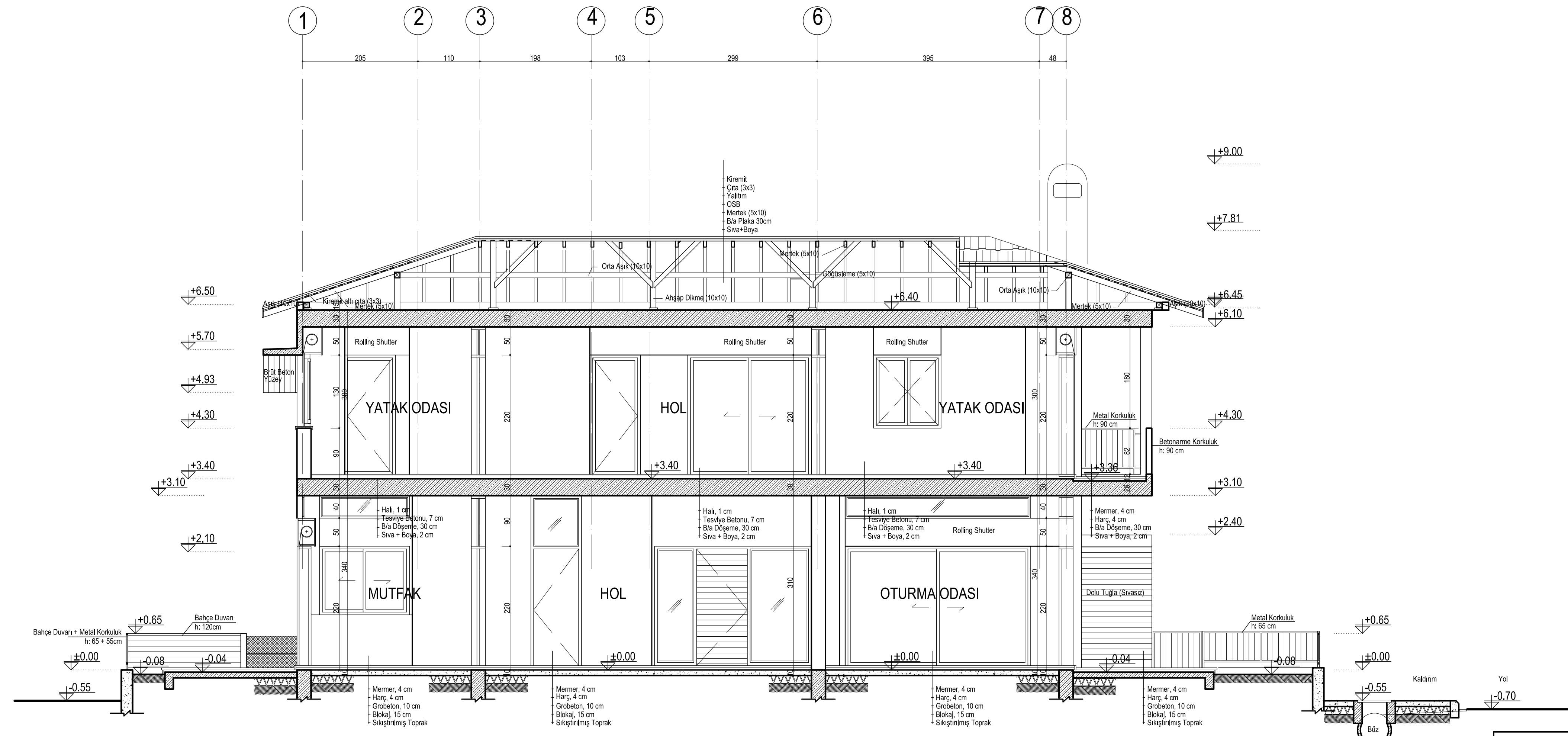

## B-B KESİTİ

Ölçek: 1/50

.....'ya  
AİT KONUT PROJESİ

MİMARİ: Ahmet V. Beaheddin	
PAFTA	KESİTLER
ÇİZEN	.....
TARİH	PAFTA No: M05
	ÖLÇEK: 1/50

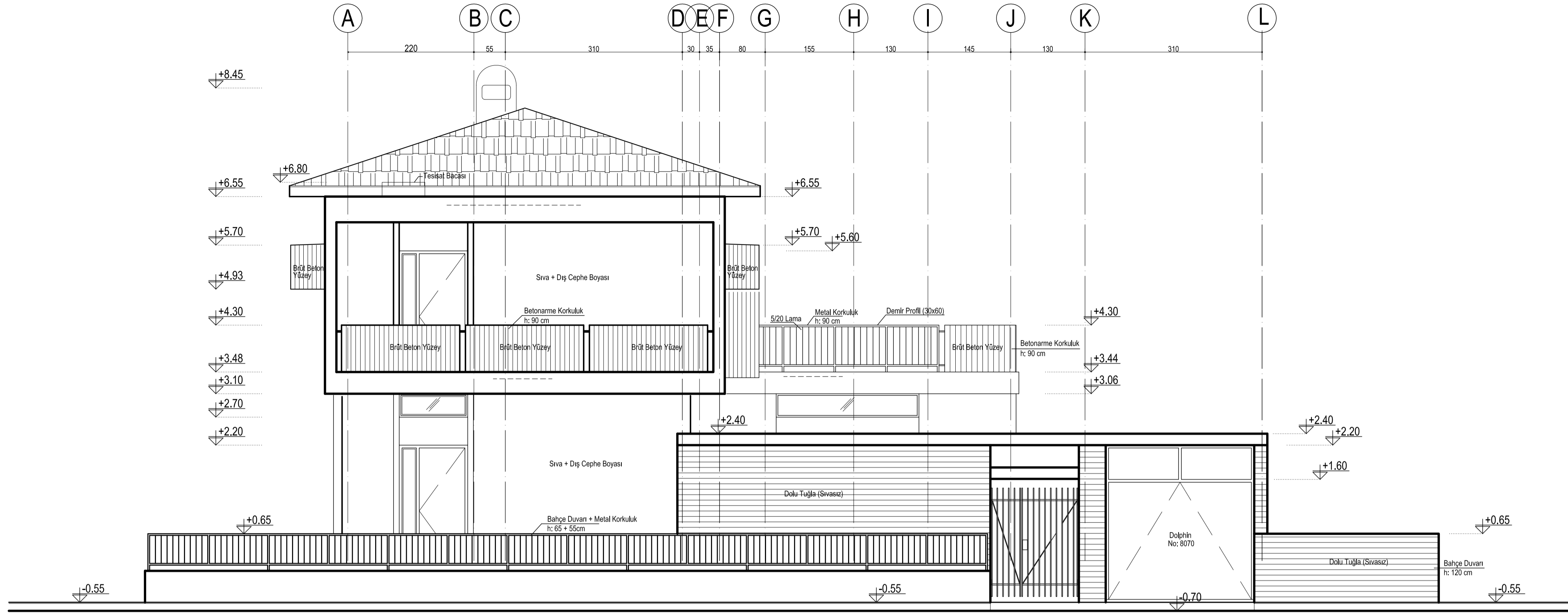

**KUZEY CEPHESİ**  
ÖLÇEK:1/50

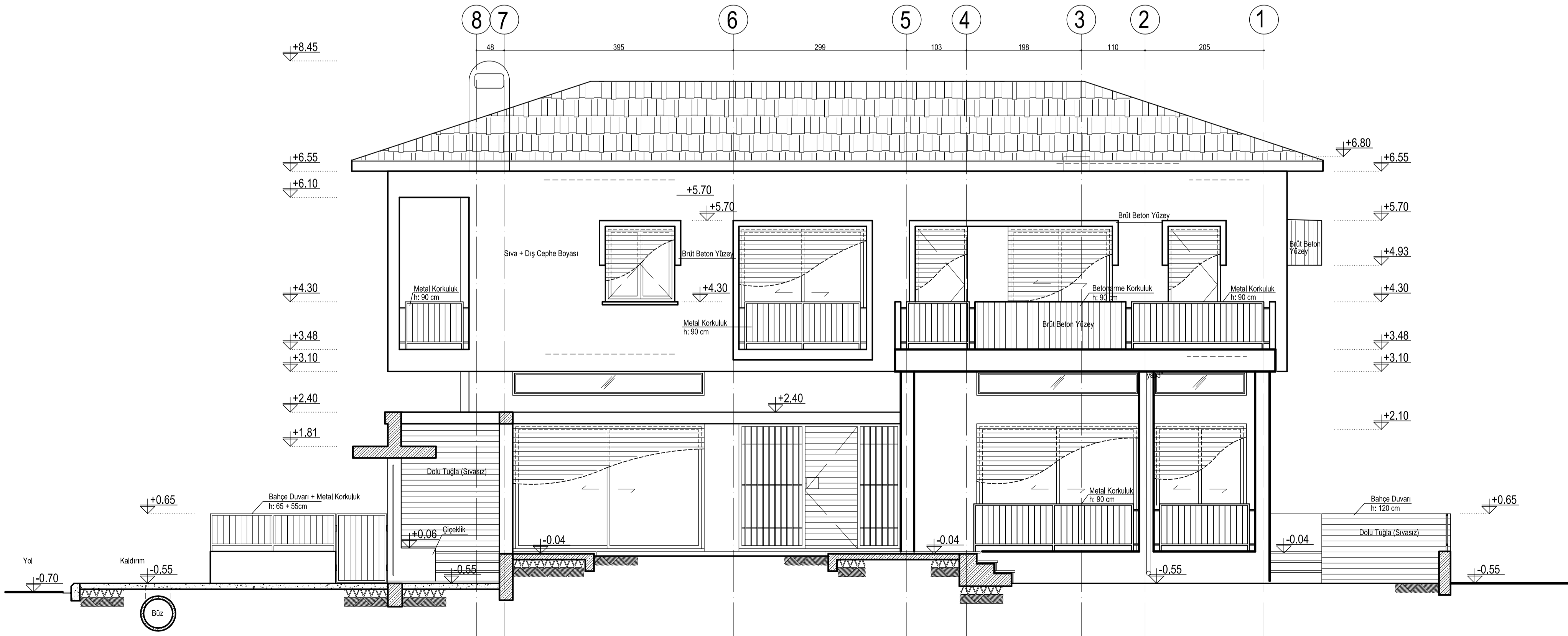

**BATI CEPHESİ**  
ÖLÇEK:1/50

..... 'ya  
AİT KONUT PROJESİ

MİMARİ: Ahmet V. Beaheddin	
PAFTA	KUZEY VE BATI CEPHESİ
ÇİZEN	.....
TARİH	PAFTA No: M06
	ÖLÇEK:1/50



**GÜNEY CEPHESİ**  
ÖLÇEK:1/50

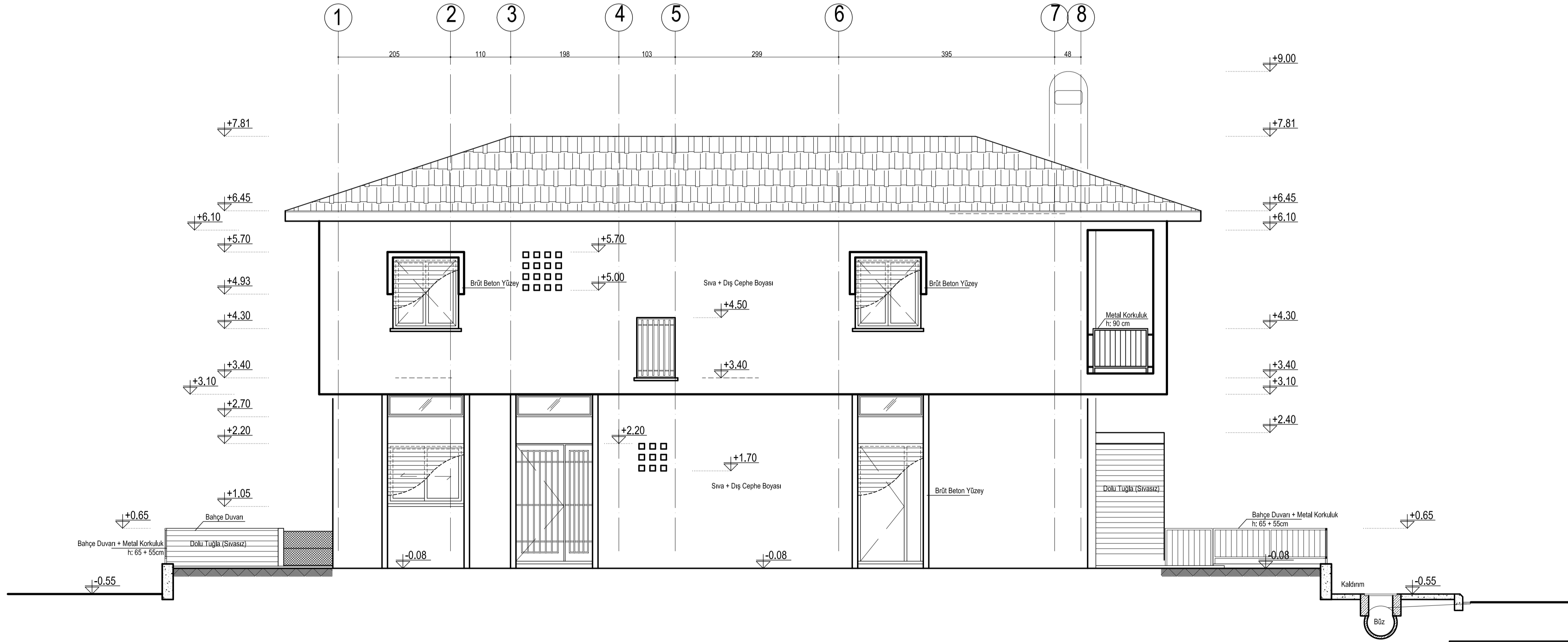

**DOĞU CEPHESİ**  
ÖLÇEK:1/50

..... 'ya  
AİT KONUT POJESİ

MİMARİ: Ahmet V. Beaheddin

PAFTA GÜNEY VE DOĞU CEPHESİ

ÇİZEN

TARİH

PAFTA No:  
M07

ÖLÇEK:1/50